

## Wiring

- Having correctly identified the wiring from your existing light fitting, connect to the quick fit connection block in the following way:

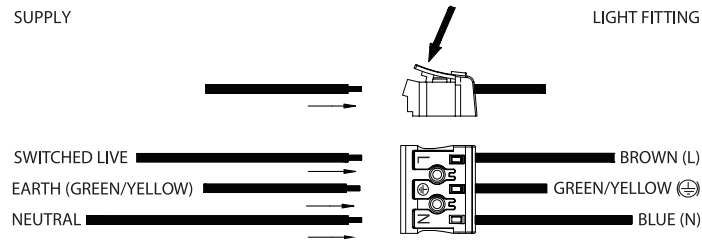

## Check that...

- You have correctly identified the wires.
- The connections are tight.
- No loose strands have been left out of the terminals.

## Instruction leaflet

# Broco Flush

78585



## Care and Safety

- We recommend cleaning with a soft dry cloth. Do not use solvents or abrasive cleaners as these could damage the finish.
- For your safety, always switch off the supply before cleaning.

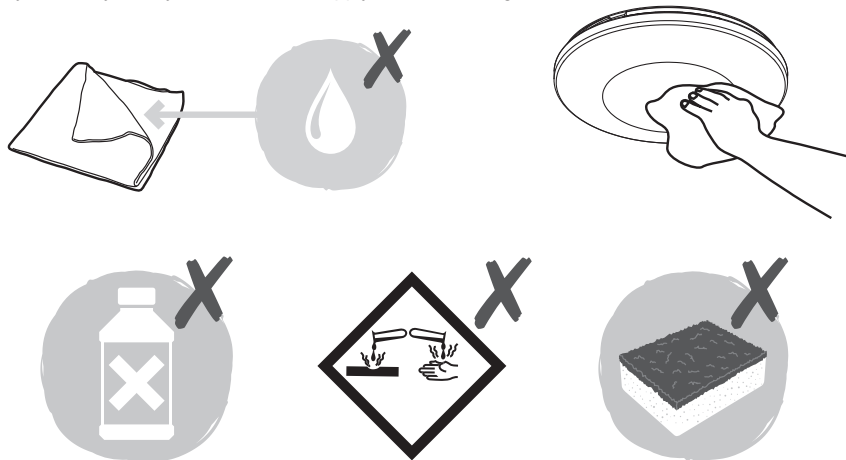

Iss .2 26/12/2018

CE

saxby  
lighting

Thank you for purchasing this light fitting. Please read the instructions carefully before use to ensure safe and satisfactory operation of this product. Please retain these instructions for future reference.

## Warning

Please read these instructions carefully before commencing any work.

This unit must be fitted by a competent and qualified electrician.

Install in accordance with IEE Wiring regulations and current Building Regulations.

Check the pack and make sure you have all of the parts listed.

To prevent electrocution switch off at mains supply before installing or maintaining this fitting. Ensure other persons cannot restore the electrical supply without your knowledge.

This light fitting should be connected to a circuit with a 30mA RCD fitted.





If replacing an existing fitting, make a careful note of the connections.

Cables must be protected using suitable conduit or plastic trunking.

We recommend that you use H05RN-F specification cable (not supplied) which is an outdoor grade, rubber sheathed cable. The mains supply cable must have a minimum cross sectional area of 1.0mm<sup>2</sup>

The products can be wall or ceiling mounted. If wall mounting ensure that the power supply is at the bottom.

## Technical data

Supply Voltage:	240V~, 50 Hz
Bulb Type:	LED (16W) SMD 2835 3000K
	The light source of this luminaire is not replaceable; when the light source reaches its end of life the whole luminaire shall be replaced.
	Conformity with all relevant EC Directive requirements.
	Waste electrical products should not be disposed of with household waste. Please recycle where facilities exist. Check with your Local Authority or local store for recycling advice.
	Class I product, must be connected to earth.
	This product is not suitable for dimming.
<b>IP44</b>	Splash-proof

## Layout

- Plan the desired layout of these fittings carefully, ensuring the cables will reach the distances each light fitting.
- Avoid locating any cables in positions that would cause a hazard. Position cables and junction boxes (not supplied) away from areas where they may be at risk from being cut, trapped or damaged.
- If this unit is being fitted in a room containing a bath or shower, a 30mA RCD must be used - in accordance with IEE regulations.
- This product is suitable for use in living areas, Bathroom Zone 2 and outside of zones.

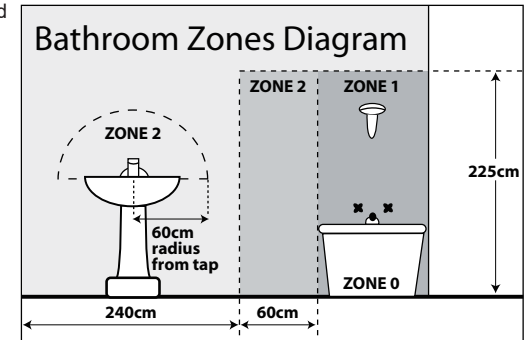

## Installation

- Existing fittings must be completely removed before installation of a new product. Before removing the existing fitting, carefully note the position of each set of wires.
- Note that the switch is turned off before installation.
- Rotate and remove the shade.
- Hold the product in place and mark the position of the holes. Ensure the wall is capable of holding the weight of the product, or if fitting to a ceiling, ensure there is a joist at the point of fixing to support the weight of the product.
- Fix the base to the wall using the screws and plugs. Take care to avoid damaging any concealed wiring and pipes. The correct fixings should be used for brick, cavity walls or plasterboard.
- Pierce a hole in the grommet, and pull the cable through.

## Commissioning

- Ensure that the screws and cable entry points are sealed to maintain the IP rating of the product.
- Refit the shade, ensuring that the seals are correctly located.
- Gently push your chosen casing onto the shade until it clips in place.
- Replace fuse or circuit breaker and switch on. Your light is now ready for use.